



International Product Guide 2026

Equipment for chemical synthesis, process development, evaporation and work-up

World leaders in innovative productivity tools for chemists

Radleys provides innovative chemistry equipment for safer, cleaner, greener and more productive chemical research.

We have been manufacturing scientific glassware and laboratory instruments for over 60 years and our customers include leading blue-chip industrial and academic research facilities around the world.

Our areas of expertise are focused on equipment for chemical synthesis, process development, work-up and evaporation.

Who uses Radleys?

If you are heating, cooling or stirring liquids, then you can benefit from the technology we offer.

The Radleys benefits

- Increased throughput for improved productivity
- Savings in time, space and money
- Better yields and improved results
- Safer, cleaner and greener working practices
- Reliable and reproducible results

Doing it differently

We believe that forward-thinking scientists and chemists are always seeking better ways of doing what they do.

Our team of R&D chemists and engineers look at every detail of the chemistry workflow, to identify what changes can be made to improve the methods, apparatus and glassware that are used everyday.

Chemistry and high-tech engineering

Indeed, it is this unique blend of chemistry and engineering expertise that has allowed us to develop many of the successful and innovative solutions we offer today.

Partnerships

In the UK we are distributors for the full range of Heidolph Instruments and Huber Thermoregulators.

huber

heidolph
research made easy

Scale	From RESEARCH... ...to DEVELOPMENT
	From BENCHTOP... ...to PRODUCTION

Position	From SINGLE... ...to PARALLEL
	From 1... ...to 24

Temperature	From DRY ICE... ...to CIRCULATORS
	From -120 °C... ...to +425 °C

Volume	From VIALS... ...to JACKETED VESSELS
	From 0.1 ml... ...to 35 litres

Stirring	From MAGNETIC... ...to MECHANICAL
	From 30 rpm... ...to 2000 rpm

Control	From MANUAL... ...to AUTOMATIC
	From DIY... ...to SOFTWARE CONTROL

Automated Reaction Station

Mya 4 Reaction Station

Pages 4/5



Jacketed Lab Reactors

Reactor-Ready Mini Lab Reactor

Page 8/9



Reactor-Ready Flex Lab Reactor

Page 10/11



Reactor-Ready Filter Lab Reactor

Page 12



Reactor-Ready Duo Lab Reactor

Page 13



Reactor-Ready Pilot Lab Reactor

Page 14



Custom/Bespoke Reaction Systems

Page 15



Control Software

AVA PC

Page 16/17



AVA Pad

Page 16/17



Benchtop and Hotplate Tools

Findenser Air Condenser

Page 18



Heat-On Block System

Page 19



Cool-It Insulated Bowls

Page 20



StarFish Work Station

Page 21



Carousel Stirring Hotplates

Page 22



Overhead Stirrers

Page 23



Parallel Reaction Stations

Carousel 12 Plus Reaction System

Page 24



Cooled Carousel 12 Plus Reaction Station

Page 25



Carousel 6 Plus Reaction Station

Page 26



Cooled Carousel 6 Plus Reaction Station

Page 27



Tornado Overhead Stirring System

Page 28



Storm Work Station

Page 29



Breeze Work Station

Page 29



GreenHouse Plus Parallel Synthesiser

Page 30



GreenHouse Blowdown Evaporator

Page 31



GreenHouse Work-Up Station

Page 32



Carousel Work-Up Station

Page 33





Mya 4™ Reaction Station



One reaction station with limitless possibilities

A 4-zone reaction station offering safe and precise heating, active cooling, software control and data-logging for 24/7 unattended chemistry

Features

- 4 Independent zones - each with heating and active cooling
- -30 °C to +180 °C
- 2 ml to 400 ml vessels - wide range of styles
- Magnetic and overhead stirring
- Software - control and log results automatically
- Control 3rd party devices



Safer, cleaner, greener and more productive

- Replace inefficient, messy and unsafe oil and ice baths
- Save space compared with separate reaction set-ups
- Software control improves safety, reduces manual errors, and allows 24/7 unattended chemistry, for increased productivity
- Create, repeat and share experiments and results with ease and accuracy
- Easily manage complex multi-step and multi-device experiments
- Integrate and link 3rd party devices such as syringe pumps and pH sensors



Touchscreen Control Pad



Wide range of vessel styles and sizes

- 2 ml to 400 ml vessels
- Vials, tubes, round bottom flasks and straight sided process vessels

Mya Compact Stirrer

- Stirs from 100 to 1000 rpm
- Control each position independently
- Powerful, high torque motor
- Tool-free attachment

Reflux Head

- Water-cooled
- Efficient refluxing
- Distributes inert gas



Excellent visibility

- Easily view your vessel contents

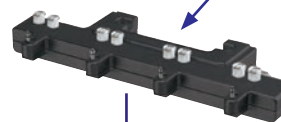

Manifold Head

- Distributes water for glass condensers
- Distributes inert gas

Up to 200 °C difference in adjacent zones

- High performance insulation minimises zone cross-talk

Temperature -30 °C to +180 °C

- Independent control of each zone
- Block or solution control
- Pt100 temperature probes

Cool to -25 °C with tap water

- No need for a separate chiller
- Powerful Peltier technology provides rapid cooling

Space saving

- Compact benchtop footprint
- Less space than 4 separate reaction set-ups

Magnetic stirring from 100 to 1000 rpm

- Control each position independently

Touchscreen Control Pad

- Supplied as standard
- Intuitive and easy to use
- Set automated profiles or use manual control
- Compact design with 10" display

Single or multi-user operation

- Control heating/cooling and stirring of each zone independently

Optional PC Control Software

- Integrate and control 3rd party devices such as pumps, balances and pH sensors



Configure Mya 4 in the way that suits your chemistry

A flexible tool for a wide range of applications, from discovery chemistry to process development

Applications:

- Process development
- Design of Experiment (DoE)
- BioPharma research
- Scale up
- Route scouting
- Crystallisation studies
- Polymorph screening
- Lead optimisation
- Reaction optimisation
- Reagent, catalyst and solvent screening

Mix & Match

One reaction station with a wide range of options and accessories to fit your needs

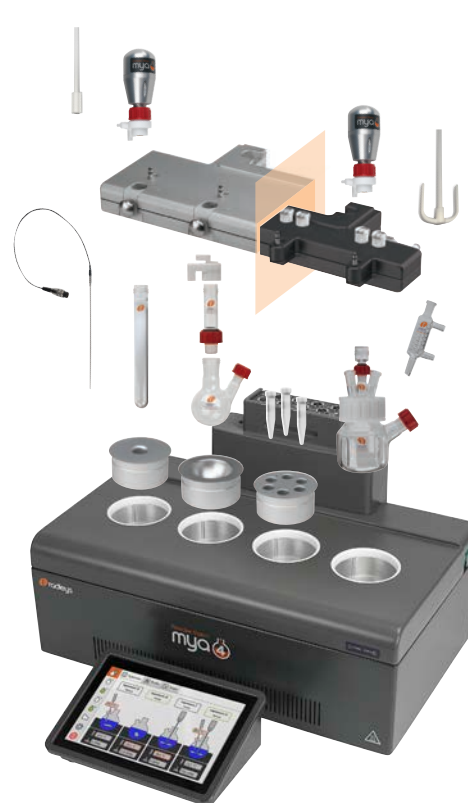

Stirring options
Overhead / Magnetic stirring

Head options
Manifold / Reflux / Support Head

Multi-neck lids or Reflux tubes
Glass or PTFE lids
Standard or wide-neck reflux tubes

Vessel styles and volumes
Tubes, vials, RBFs and process vessels
from 2 ml to 400 ml

Aluminium inserts
For each vessel size

Select accessories
Temperature probes, condensers, funnels,
storage solutions and many more

Touchscreen Control Pad

- Supplied as standard with Mya 4
- Intuitive and easy to use
- Compact footprint
- Set automated profiles or use manual control
- Large 10" display



PC Control Software - optional

- Integrate and control 3rd party devices
- Create complex experiments with any number of steps
- Report Wizard creates reports in rich text format or export results in CSV

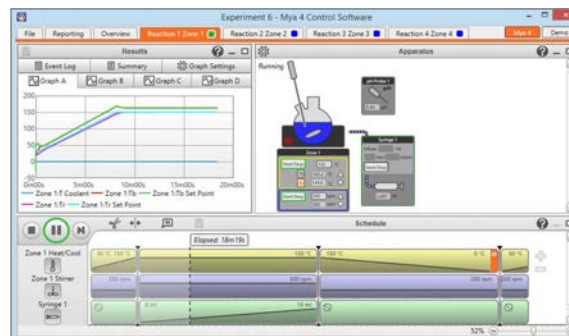
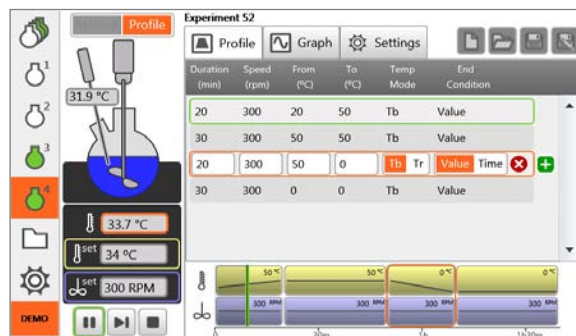

Jacketed Reaction Systems Quick Guide

The Reactor-Ready Jacketed Lab Reactor range



Reactor-Ready Mini

Reactor-Ready Flex

Reactor-Ready Filter

Reactor-Ready Duo

Reactor-Ready Pilot

Vessel volume range	50 ml to 500 ml	100 ml to 5 L	1 L to 2 L	100 ml to 5 L	5 L to 35 L
Key benefits	Space-saving benchtop jacketed lab reactor designed for precise small-scale chemistry	The original modular benchtop jacketed lab reactor designed for rapid, mess-free vessel exchange	Reaction and filtration in a single jacketed vessel setup. Ideal for workups, crystallisation, and product isolation	All the benefits of Reactor-Ready Flex with two vessels on one compact framework	Floor-standing pilot-scale jacketed lab reactor for easy scale-up or scale-down
Vessels per framework	1	1	1	2	1
Temp Range	-70 °C to +230 °C	-70 °C to +230 °C	-30 °C to +180 °C	-70 °C to +230 °C	-70 °C to +230 °C
Rapid vessel exchange	✓	✓	✓	✓	✓
Dimensions (WxDxH)	270 x 339 x 824 mm	456 x 570 x 1103 mm	456 x 570 x 1208 mm	600 x 485 x 1103 mm	540 x 650 x 1884 mm
Lid Flange Size	DN60	DN100	DN100	DN100	DN200
Synthesis	✓	✓	✓	✓	✓
Filtration	✗	✗	✓	✗	✗
Reflux / Distillation	✓	✓	✓	✓	✓

Custom/Bespoke Reaction Systems

100 ml to 35 litres

We also supply traditional or custom designed reaction systems to meet your specifications.

To find out more about Custom Reactor Systems, See page 15



AVA Software Jacketed Lab Reactor Control

One Software. Any Reactor. Effortless Automation.



To find out more about our easy-to-use AVA software, See page 16/17



Why choose the Reactor-Ready Range?

A range of versatile reactors for confident scale-up and scale-down

Reactor-Ready is a range of versatile jacketed lab reactor systems with interchangeable vessels. Designed to provide a single framework for a range of vessel volumes, with easy and mess-free vessel exchange. Use one fumehood, circulator and overhead stirrer to save yourself time, space and money. Ideal for busy labs working on multiple projects.

Reactor-Ready Mini: 50 ml to 500 ml, in a small footprint

Reactor-Ready Flex: 100 ml to 5 litres

Reactor-Ready Duo: 100 ml to 5 litres, with two vessels on one space-saving frame

Reactor-Ready Filter: 1 litre and 2 litres, for synthesis and filtration in the same vessel

Reactor-Ready Pilot: 5 litres to 35 litres, on a floor-standing frame.

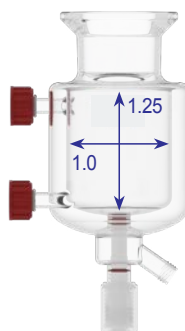

Consistent vessel geometry
(1.25:1 height to diameter ratio)
across the ranges simplifies
scaling up or down.

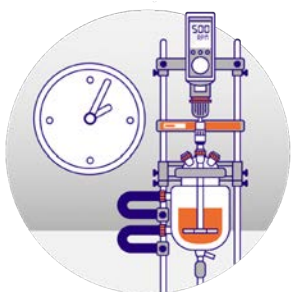

Compact and flexible for busy labs

Save time, space and money with a single workstation. Swap vessels between projects in minutes and without tools.



Scale without compromise

From 50 ml to 35 litres, the Reactor-Ready range lets you scale your chemistry easily, with a system for every stage.

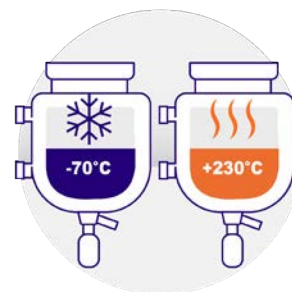

Precise temperature control

Accurate and consistent temperature control thanks to optimised vessel geometry and jacket design.



Control multi-device reactions

Effortlessly integrates with AVA software for safe and precise automated reaction control and data logging.



Proven success worldwide

Over 3000 systems installed around the world. Trusted by top pharmaceutical companies.



Expert support at every step

Our experienced team offers practical advice to help accelerate your chemistry.



Reactor-Ready™ Mini Lab Reactor - 50 to 500 ml

Small Footprint. Precise Control. Confident Scale-up

Reactor-Ready Mini is a small benchtop jacketed lab reactor that accepts vessels from 50 ml to 500 ml. Designed for small-scale chemistry, it offers the precision, control and flexibility of a full-size Reactor-Ready system in a compact, space-saving footprint.



Small footprint,
big performance

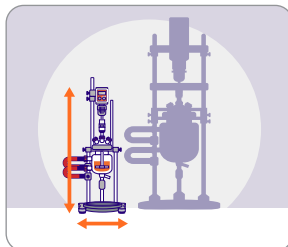

Scalable volumes
from 50 to 500 ml

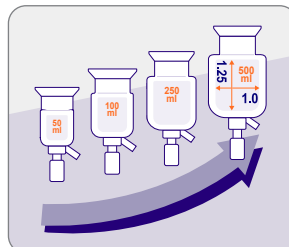

Precise control
at a small scale

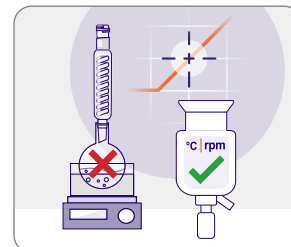

Rapid vessel
exchange

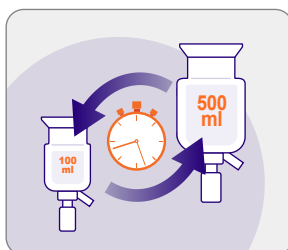

Greener & more
cost-effective



Miniaturisation
throughout

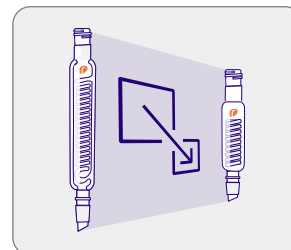

ava pad

Compact all-in-one
reactor controller.
Effortless automation.



Compact stirrer support

- Simple, tool-free setup
- Accepts a range of compact overhead stirrers

Compact footprint

- W x D x H (mm):
270 x 339 x 824



Patented stirrer coupling

- Drop-in
- Self-aligning
- Tool-free



A wide range of accessories

Including PTFE stirrer paddles, temperature probes and lids, plus popular glassware such as condensers, funnels, adapters etc.

PTFE vessel clamp

- Rapid vessel exchange
- Quick release and tool-free

Glass and PTFE lids

- Vacuum-tight sealing with FEP-encapsulated O-ring
- DN60 flange across all vessel sizes



RS20 Control Mini Overhead Stirrer

- Lightweight and compact
- RS232 connectivity for software control

PEEK hose couplings

- Quick release tool-free connection.
- Chemically resistant PEEK

Wide range of vessels

- 50 ml to 500 ml
- Vacuum jacketed option
- Process vessel shape mimics plant scale geometry



Draindown manifolds

- Mess-free vessel exchange
- Reduces stress on the vessel sidearms

Zero dead space drain valve

- Wide bore – 15 mm
- Design prevents over-tightening



Reactor-Ready™ Mini Lab Reactor - 50 to 500 ml

A small benchtop jacketed lab reactor with vessels that can be swapped in minutes

- Compact, versatile jacketed lab reactor.
- The same flexibility and precision as Reactor-Ready Flex in a fraction of the space.
- For early-stage process development, scale-down studies and small-scale chemistry.
- Save fumehood space, reduce waste and achieve reproducible results to scale up, or down with confidence.
- A modular reaction system that can easily be configured to suit your budget and application.
- For further safety, precision and reproducibility, add AVA Software.

It's easy to configure your Reactor-Ready Mini...

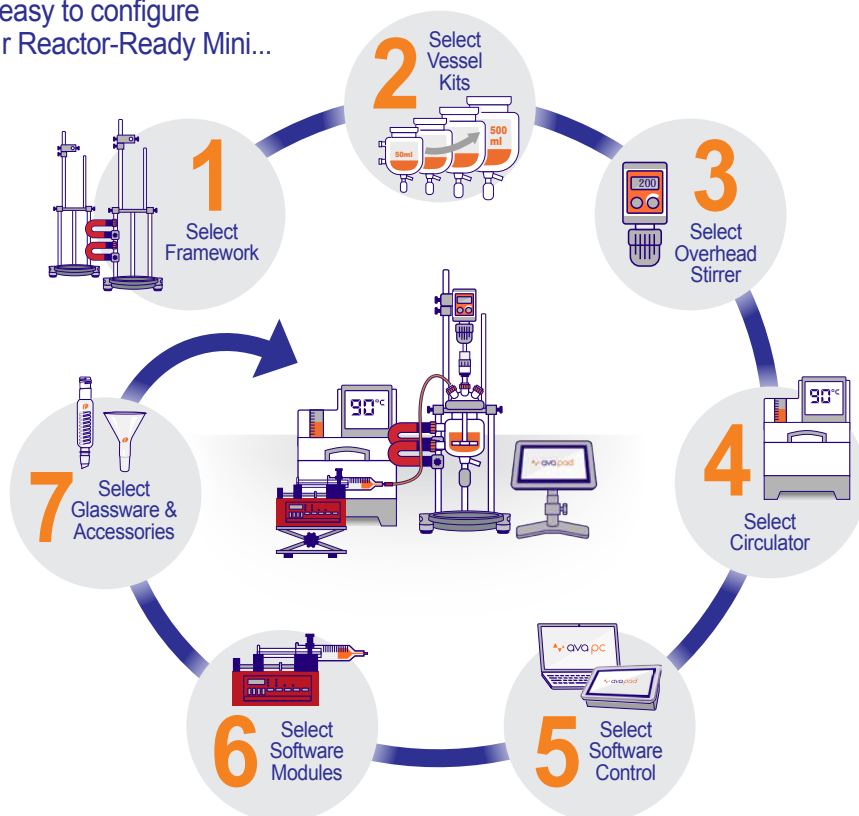

7 simple steps

1. Select Framework
2. Select Vessel Kits
3. Select Overhead Stirrer
4. Select Circulator
5. Select Software Control
6. Select Software Modules
7. Select Glassware & Accessories

Reactor-Ready Mini Pro

With draindown manifolds for rapid, mess-free vessel exchange

Draindown Manifold Kit

- Easy thermal fluid draindown
- Rapid and mess-free vessel exchange
- Manifolds take the weight of the hoses



Most popular choice

Reactor-Ready Mini Starter

For more limited budgets, connect your vessel directly to your circulator

Tool-free hose connectors

- Connect your vessel directly to your circulator hoses
- Chemically resistant PEEK sidearm connectors with no glass-to-metal contact
- Choose between M16 & NW12
- Must be ordered separately





Reactor-Ready™ Flex Lab Reactor - 100 ml to 5 litres

A modular benchtop jacketed lab reactor system that accepts a range of vessels on a single framework

Reactor-Ready Flex is a compact, modular benchtop jacketed lab reactor that accepts a wide range of vessels. It's easy to configure your Reactor-Ready Flex system to suit your application and budget.



Vessels 100 ml to 5 Litres



Rapid vessel exchange



Temp: -70 °C to +230 °C



Self-aligning stirrer

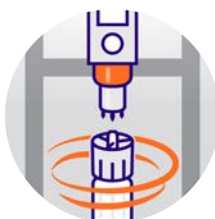

Quick vessel drain down



Automation: Log & Control



ava pad

Control and log any reactor:
Subscription-free automation.



Simple stirrer alignment

- 3-axis stirrer support
- Easy and tool-free

Patented stirrer coupling

- Drop in
- Self-aligning
- Tool-free

Vessel Kits

Convenient vessel kits make buying vessels and accessories quick and easy



Hose couplings

- Quick-release
- Connect in seconds
- Chemical-resistant PEEK

Unique vessel clamp

- Self-centering
- Quick-release
- Change vessels in minutes



PTFE Stirrers

A choice of popular stirrer paddles

Wide range of vessels

- 100 ml to 5 litres
- Vacuum jacketed option
- Vessel shape mimics plant scale geometry

Zero dead space drain valve

- Wide bore
- 15 or 25 mm available
- Design prevents over-tightening

Individual manifolds

- Easy connection
- Easy drain-down
- Reduces stress on vessel sidearms

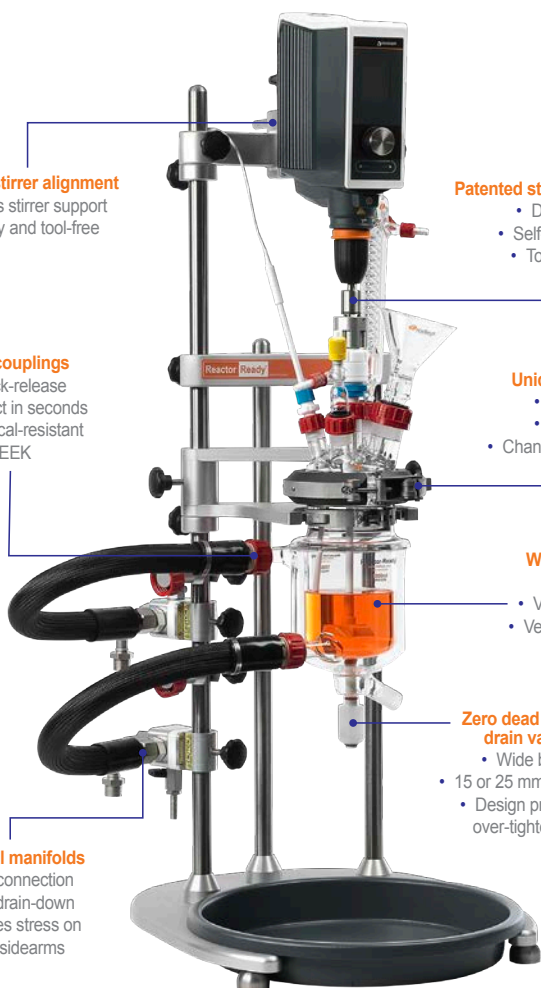

Reactor-Ready™ Flex Lab Reactor - 100 ml to 5 litres

A versatile workstation designed for rapid, mess-free vessel exchange

- Use one fumehood, circulator and overhead stirrer to save yourself time, space and money.
- Perfect for busy labs working on multiple projects.
- Start by selecting one of two framework options: Pro or Starter.
- Upgrade from Starter to Pro at any time for a truly flexible solution.

It's easy to configure your Reactor-Ready Flex...

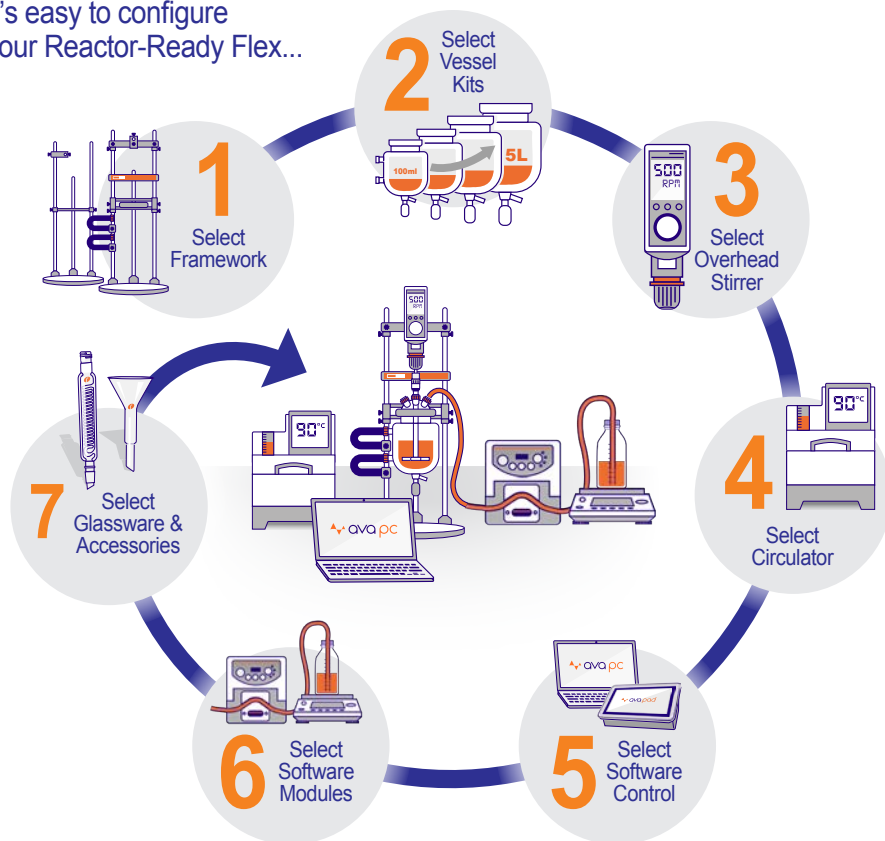

7 simple steps

1. Select Framework
2. Select Vessel Kits
3. Select Overhead Stirrer
4. Select Circulator
5. Select Software Control
6. Select Software Modules
7. Select Glassware & Accessories

Reactor-Ready Pro

Feature rich for maximum flexibility and rapid vessel exchange

I-Beam stirrer support

- Easy alignment on 3 axes

Integrated vessel support

- Rapid vessel exchange
- Design ensures horizontal alignment
- Integrated carbon-filled PTFE vessel clamp

Draindown Manifold Kit

- Easy thermal fluid draindown
- Rapid and mess-free vessel exchange
- Manifolds take the weight of the hoses



Reactor-Ready Starter

Core functionality for those with limited budgets

Compact stirrer support

- Manual alignment

Vessel support plate

- Manual alignment
- Separate vessel clamp

Tool-free hose connectors

- Connect directly to circulator hoses
- Chemically resistant PEEK with no glass-to-metal contact
- Choose between NW12, M16 & M24 connectors





Reactor-Ready™ Filter Lab Reactor



Reaction and filtration in a single jacketed vessel setup, ideal for crystallisation, reaction workups and product isolation

Reactor-Ready Filter Lab Reactor combines a jacketed lab reactor and a filter into one system. This allows users to isolate their product without having to manually transfer their material from reactor to a separate filter, saving time and reducing product losses.

Features

- Filter vessels are fully jacketed down to base for accurate temperature control.
- Choice of jacketed filter vessels in 1 and 2 litre volumes.
- Temperature range of filter vessels: -30 °C to +180 °C (jacket temperature).
- Rapid vessel exchange with quick-release vessel clamp and hose couplings.
- Also accepts the full range of Reactor-Ready vessels.
- Innovative hose manifolds allow easy thermofluid drain down.
- Accepts all leading brands of overhead stirrer for agitated slurring and filtrations.
- Filter base accepts pre-cut filter membranes or you can cut your own membranes to size.
- Filter support plate aligns the base with the vessel for tool-free assembly.

Convert your Reactor-Ready Flex to a Filter Reactor



Control and log any reactor:
Subscription-free automation.

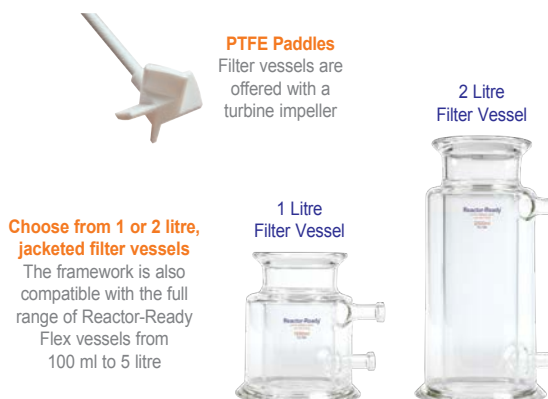
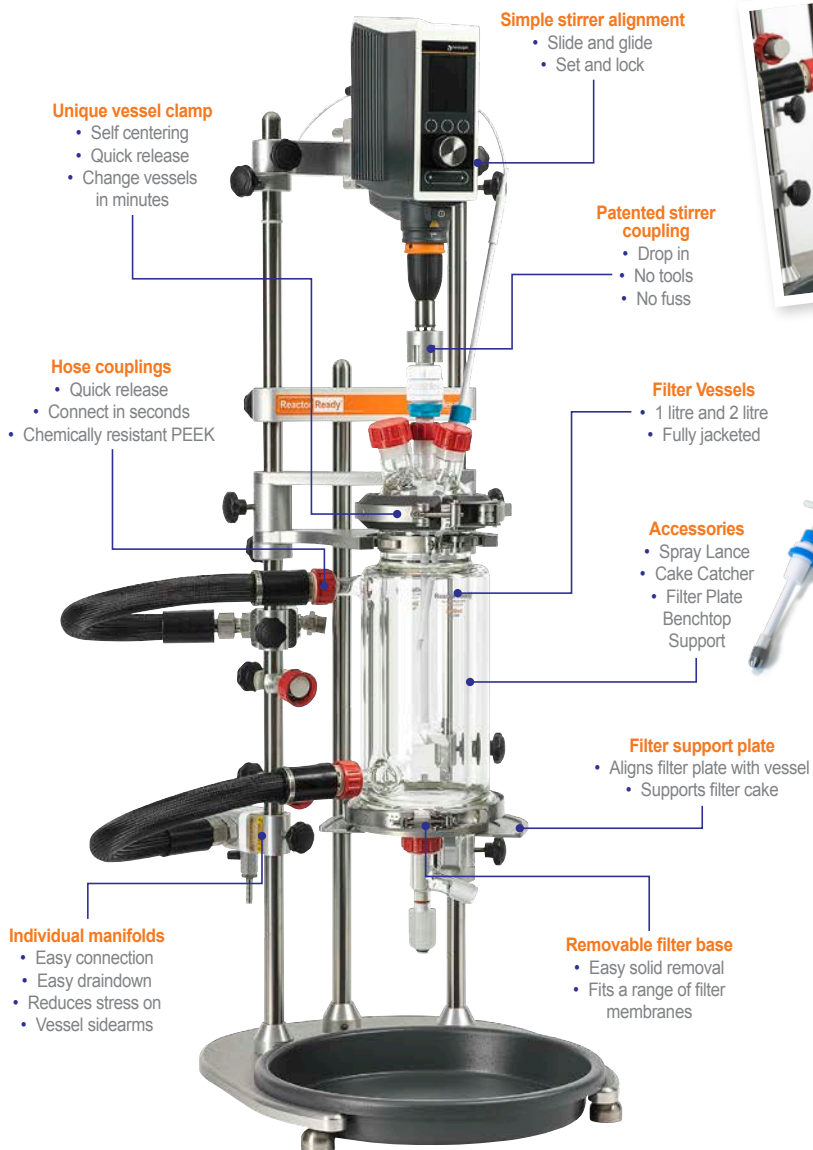

Choose from 1 or 2 litre, jacketed filter vessels

The framework is also compatible with the full range of Reactor-Ready Flex vessels from 100 ml to 5 litre

Reactor-Ready™ Duo Lab Reactor - 100 ml to 5 litres

All the benefits of Reactor-Ready with two vessels on one compact framework

Reactor-Ready Duo shares the same unique features as Reactor-Ready Flex, but holds two independent jacketed glass reaction vessels. The system can be configured to operate with a single thermoregulator controlling the jacket temperature of both vessels simultaneously or with two thermoregulators controlling the temperature of each vessel independently.

Features

- Rapid exchange of both vessels independently, with quick-release vessel clamp and hose couplings.
- Choice of manifold kits allow two vessels to run from a single thermoregulator or two separate thermoregulators.
- System accepts two overhead stirrers which can be moved independently.



Applications

- Parallel synthesis or reaction optimisation: use similar or different size vessels and vary stirring speed, stirrer shape and temperature between vessels.
- Two stage reaction: transfer reactant from one vessel to the other using vacuum or a pump.
- Single reaction vessel: using the second vessel as either a receiving or feed vessel (where reagents can be pre-heated or pre-cooled prior to addition).
- Use optional AVA Software to control fluid transfer between vessels.

1000 ml Process



Process vessels
Mimic the geometry of plant scale reactors, with a 1.25 to 1 ratio

ava pc

Control and log up to four reactors.
Effortless automation.



Unique vessel clamp

- Supports two vessels
- Change vessels independently
- Change vessels in minutes

Vessels

- 100 ml to 5 litres
- Combine different volumes
- Vacuum jacketed option

Thermofluid manifolds

- Choice of two manifold kits: single circulator manifolds and double circulator manifolds



Simple stirrer alignment

- Set and lock
- Independent stirring for each vessel

Patented stirrer coupling

- Drop in
- No tools
- No fuss

Hose couplings

- Quick-release
- Connect in seconds
- Chemical-resistant PEEK

Strong framework

- Heavy duty base
- Solid s/steel support rods
- Large drip tray

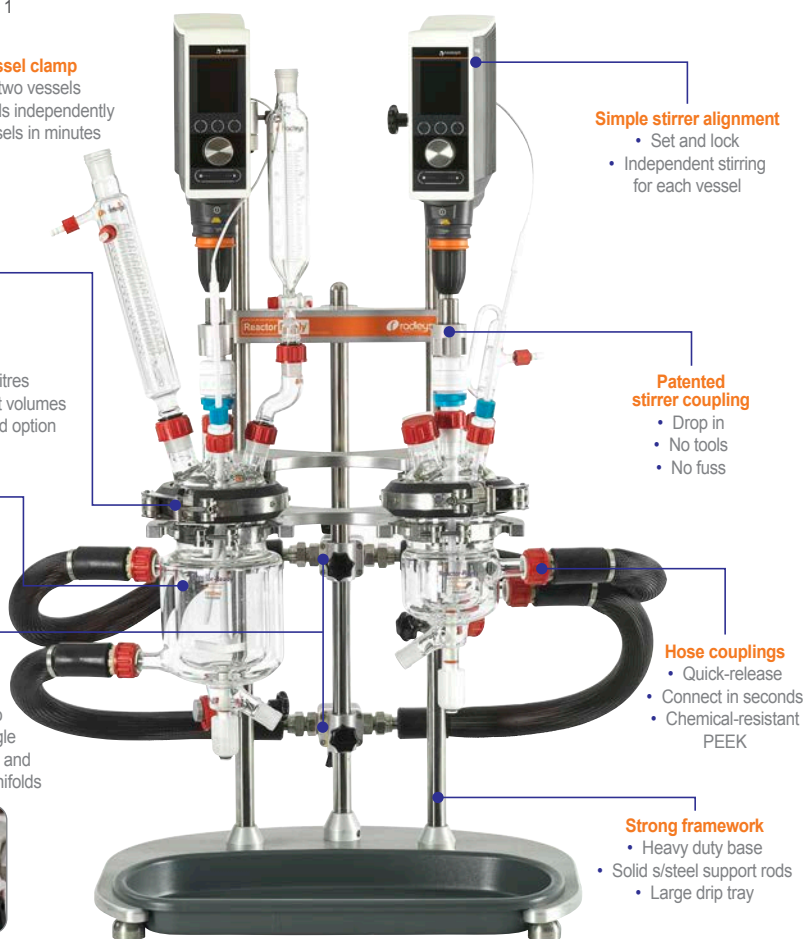

Supports two glass reaction vessels of different or similar volume from 100 ml to 5 litres



Similar vessel sizes with double circulator manifold kit



Different vessel sizes with double circulator manifold kit



Similar vessel sizes with single circulator manifold kit



Different vessel sizes with single circulator manifold kit

How to order Reactor-Ready Pilot

1. Select the Reactor-Ready Pilot Core.



2. Choose the lid you require (custom options available).



3. Choose the Vessel Kits you need.



4. Select the Lower Support Plate if using the 30 or 35 litre vessels



5. Select the overhead stirrer you need.



6. If you need a thermoregulator, hoses, hose adapters, thermofluid or accessory glassware, then select from the accessory list.



7. For further safety, precision and reproducibility, add AVA Software.



Reactor-Ready™ Pilot - 5 to 35 litres

Replace multiple reactor set-ups with a single, versatile pilot scale system with interchangeable vessels that can be swapped in minutes, not hours

Reactor-Ready Pilot is ideal for process development, scale-up, pilot and kilo labs.

Features

- Rapid vessel exchange with quick-release vessel clamp and wide bore hose couplings.
- Single jacketed vessels available in 5, 10, 15, 20, 30 and 35 litres.
- Vacuum jacketed vessels available in 5 and 10 litres.
- Vessels have a 1.25 to 1 ratio of internal height to diameter to mimic plant scale reactors.
- DN200 vessel flange.
- Accepts all leading brands of overhead stirrer and allows easy, tool-free adjustment.
- Compact stainless steel framework accepts all vessel sizes.
- Self-aligning stirrer coupling engages without the need for tools.
- Jacket temperature range: -70 °C to +230 °C.
- Hose manifolds allow easy thermofluid drain down.



Simple stirrer alignment

- 6 axis adjustment
- Slide and glide
- Set and lock

Universal stirrer support

- Accepts all leading brands of overhead stirrer

Unique vessel clamp

- Self-centering
- Quick-release
- Change vessels in minutes

Patented stirrer coupling

- Drop in
- No tools
- No fuss

Standard jacketed vessels

- Single jacketed vessels 5, 10, 15, 20, 30 and 35 litres
- Vacuum jacketed vessels 5 and 10 litres
- Zero dead space bottom outlet valve
- 1.25:1 vessel geometry

Custom vessels

- To your specific size and style
- In-house manufacturing
- Mimic plant scale geometry

Compact, mobile framework

- Corrosion-resistant stainless steel, anodised aluminium or powder-coated steel
- Option for wheels or feet

Hose couplings

- Quick-release
- Connect in seconds
- Chemical resistant PEEK
- 20 mm ID for good heat exchange

Thermofluid manifolds

- Easy connection
- Easy draindown
- Reduces stress on the vessel sidearms

Lower Support Plate

- Required for 30 and 35 litre vessels
- Easily adjustable without tools

Reactor-Ready Pilot with 35 litre vessel

5 litre vacuum jacketed vessel

35 Litre Single jacketed vessel

Reactor-Ready Pilot with 20 litre jacketed vessel

Custom/Bespoke Reaction Systems - 100 ml to 35 litres

Jacketed reaction systems designed to meet your specifications

Radleys are experts in the design and manufacture of exceptional quality scientific glassware. We have a long history (over 60 years) of working with chemists and chemical engineers in the leading industrial and academic research facilities around the world. Whether you require a multi-vessel process rig, a small benchtop reactor or a complex parallel set-up, our team of design engineers and scientific glassblowers will be pleased to help with your project.

Simply tell us what you need

The combination of features and design variations is almost limitless. Please contact our technical specialists or your local Radleys distributor to discuss your requirements.

In-house
design and
manufacture of
vessels

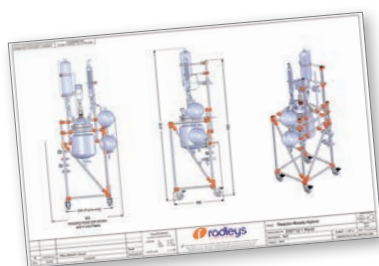
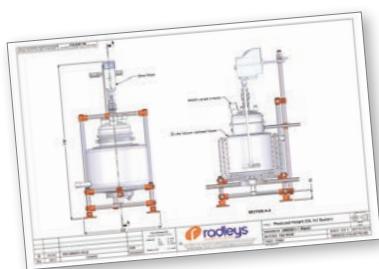

In-house design and manufacture of custom glass reaction vessels and frameworks



An installation of six 30 litre jacketed reaction systems in Shanghai, China



Scope of our services

- In-house design and manufacture
- Frameworks and supports
- Thermoregulators, chillers and circulators
- Overhead stirrers, sensors and probes
- Data logging and software control
- Installation and training

Vessels

- Single or vacuum jacketed
- Jacketed vessels to 35 litres
- Vacuum jacketed vessels to 10 litres
- Tall, squat or process vessel geometries
- Cylindrical or spherical vessels
- Split jackets and optical windows
- Conical, dish or hemispherical vessel bottoms
- Vessels with optical windows or split jackets
- Vessels with fixed or removable filters or sinters
- Glass or PTFE lids

Systems

- Multi-reactor systems for parallel synthesis
- Fermenters, bioreactors and photoreactors
- Condensers, distillation assemblies, scrubbers

Accessories

- Thermoregulators with supply and servicing
- Thermofluids, hoses and adapters
- Overhead stirrers: electric or air-powered



A custom parallel system and framework, with control software installed in Germany



Control and log your reaction system with AVA Software



AVA™ Software - Jacketed Lab Reactor Control

One software. Any reactor. Effortless automation.

AVA is a subscription-free, reactor controller that brings effortless automation to any jacketed lab reactor. Designed by chemists for chemists, it connects directly to circulators, stirrers, pumps and sensors - enabling full control and data logging from a single interface. Powerful, intuitive and affordable, AVA simplifies complex chemistry and delivers precise, safe and reproducible results - every time.

Quick to set up. Simple to use. Built for the way chemists work.



One software.
Two platforms.



Control any Jacketed Lab Reactor

Subscription free automation



Connect multiple devices from leading manufacturers



Control devices directly via the apparatus window



AVA Pad Apparatus Window

Create detailed reports and share data



AVA PC Report Wizard

View process data in real-time graphs

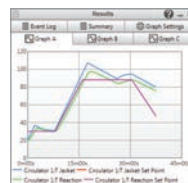

AVA PC Graph Window

Schedule window to create experiment profiles



AVA Pad Schedule Window

Connect up to 16 Devices

Supports leading manufacturers



and more...

Why choose AVA to automate your Jacketed Lab Reactor?



Boosts productivity by reducing manual tasks



Enhances process safety and control



Enables precise, repeatable reaction control



Control multi-device reactions effortlessly



Proven success worldwide



Expert support at every step

AVA™ - One software. Two platforms.

Choose between an all-in-one controller or PC-based software

AVA Pad Reactor Controller

Compact all-in-one controller

Suitable for all brands of jacketed lab reactor.

Cat No	RR20230
Device Connectivity	Integrated
User Interface	10" Touchscreen
Multiple Reactor Control	No

Suitable for

- Single Reactor
- Dual Reactor

10" Touchscreen

- Graphical display
- Pinch zoom
- Supports USB keyboard & mouse

User Management

- Multiple user profiles
- Password protection per user

Integrated connections

- RS232 x 4
- Temp sensor ports x 2
- USB x 2
- Ethernet x 1 & HDMI Output x 1



ava pad



Fumehood compatible with two mounting options

- Control Pad Benchtop Stand
- Control Pad Support Rod



AVA PC Reaction Control Software

PC based software

Suitable for all brands of jacketed lab reactor.

Cat No	RR20308
Device Connectivity	Via separate hub
User Interface	Laptop PC
Multiple Reactor Control	Yes - up to 4

Suitable for

- Single Reactor
- Dual Reactor
- Multiple reactors (up to 4)

Laptop PC Controller

- Full keyboard
- 16" LCD Display

User Management

- Single user software
- Single password protection

Separate Data Hub connections

- RS232 Ports x 4
- Temp sensor ports x 2
- Ethernet x 1

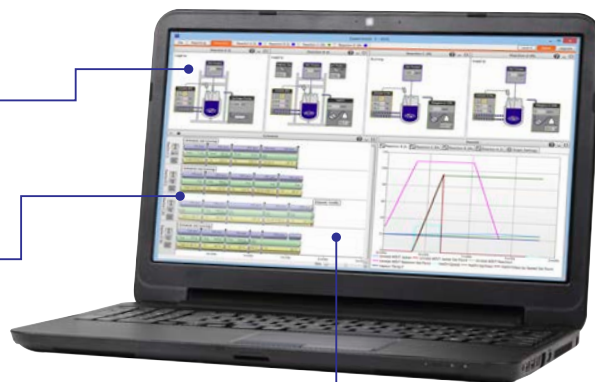

ava pc



6 simple steps





Findenser™ - prevents flooding and saves water

Replaces water-cooled condensers in over 95% of common chemistry applications

How does Findenser work?

- Findenser comprises an internal glass condenser and an external, finned aluminium jacket, between which a small amount of water is permanently sealed.
- The glass condenser design has a greater internal surface area than traditional air condensers, increasing heat transfer capacity.
- The finned jacket fits around the glass condenser, further increasing the external surface area.
- The result is a 'SUPER air condenser'.

What are the benefits?

- No risk of flooding from running water
- Eliminate the cost of water purchase and disposal
- For solvent volumes from 5 ml up to 1 litre
- Helps meet sustainable water reduction targets

Average water consumption of common household appliances compared to a Findenser and water condenser

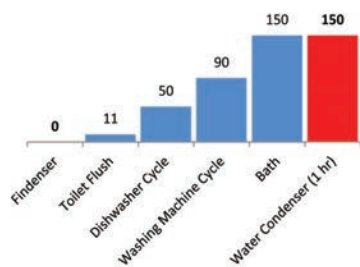

Choice of B14, B19, B24 and B29 joint sizes



B14



B19



B24



B29

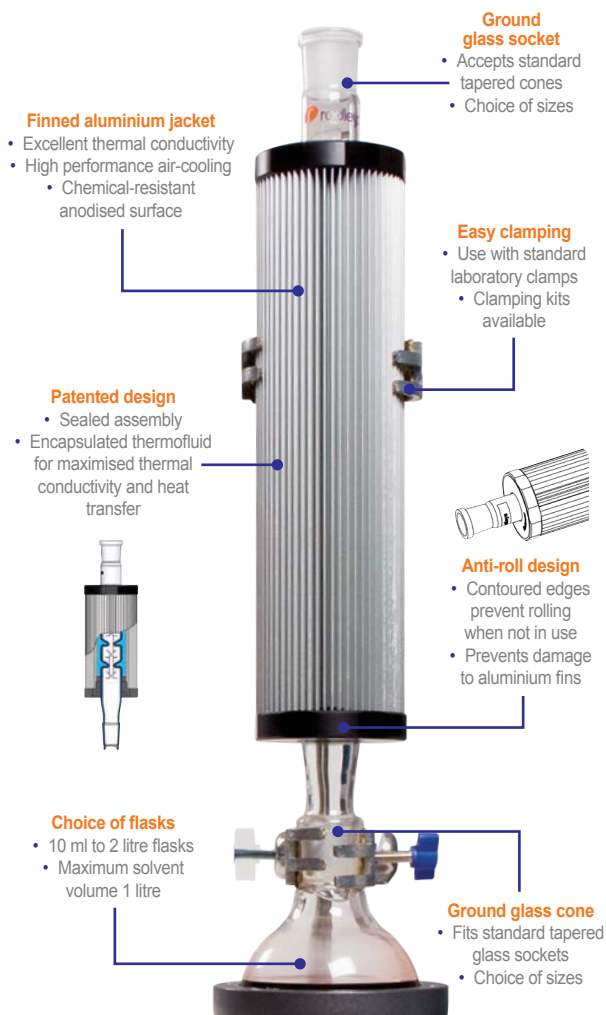

Findenser requires no running water to operate. Water is a precious resource. It makes little economic or environmental sense to waste thousands of litres just to cool a single condenser.

Performance testing

A range of solvents, in identical flasks and set-ups, were tested with a Findenser, water condenser and air condenser to record solvent loss by weight.

Findenser compared to an air condenser

For synthesis with low boiling point solvents, Findenser showed a significant improvement in solvent retention. With acetone or DCM the reaction boiled dry when using an air condenser, yet Findenser retained 95% of the solvent under the same conditions.

For synthesis with medium boiling point solvents, Findenser delivered improved solvent retention particularly with larger volumes and high temperatures.

Findenser compared with a water condenser

Under identical conditions, Findenser retained solvent to the same level (within the limits of experimental error) as a water condenser with a range of solvents. Diethyl ether is not recommended for use with Findenser.

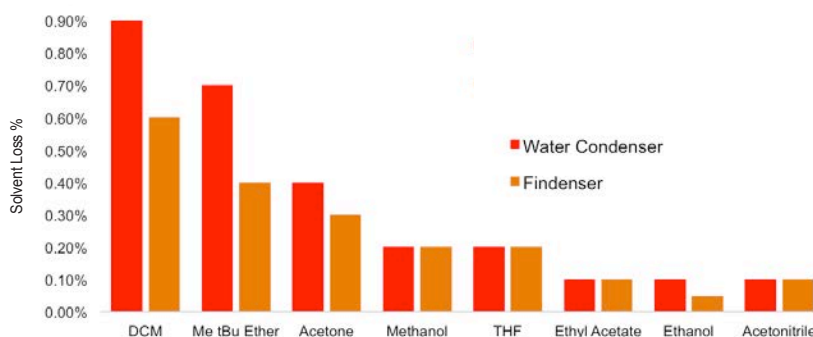

Heat-On™ Block System - *the safer alternative to oil baths*

The safest, fastest and most efficient way to heat and stir round bottom flasks from 10 ml to 5 litres

Features

- Replace messy oil baths and heating mantles and avoid spills.
- Make your chemistry safer, cleaner and faster.
- Solid aluminium blocks provide even heating.
- Lightweight design allows rapid heating.
- Uniquely shaped well design eliminates cracking of flasks.
- Blocks feature two probe holes and optional lifting handles.
- Use up to 260 °C.
- Also available for Florentine flasks, vials and tubes.



Heat-On Multi-Well Block with 50 ml and 100 ml flask inserts

Not all block designs are the same

Test results show that Heat-On heats up to 66% faster and uses 30% less energy than other brands of block.

Visit radleys.com to download the application bulletin



The risk of oil fires and injury from hot oil spills, plus the mess and cost associated with the use of oil, means that oil baths no longer represent safe working practice in labs. Heating mantles are expensive, difficult to clean, do not respond well to spills and often create hot spots when heating. Scientists are increasingly turning to specially designed aluminium blocks located on stirring hotplates to heat standard round bottom flasks.



Heat-On Multi-Well Block

- Accepts two 50 ml or 100 ml flasks, or one 150 ml flask

Two temperature probe holes

- Accept 3 mm ø probe

Lightweight design enables rapid heating

- Use up to 260 °C
- Uses 30% less energy
- Heats water 66% faster



Anodised finish

- Heat-On blocks are also available with a lower cost anodised finish if preferred

PTFE safety covers reduce the risk of burns

- Reduces surface temp. by up to 50%
- Reduces energy consumption by 15%
 - Available for the most popular Heat-On sizes

Over 50 styles and sizes to choose from

- Accepts tubes and flasks
 - 1 ml to 5 litres



260°C

Unique well design prevents flask cracking

- Unlike many other inferior blocks, Heat-On will not crack your flask when cooling



Optional lifting handles

- Quick-release mechanism for safe removal

Fluoropolymer coating

- Superb chemical resistance
- Easy to clean
- Speeds up heating times



Square hotplate adapter

- Allows Heat-On to sit on a square top plate up to 200 x 200 mm

Fits all leading hotplate brands

- Suitable for 145 mm ø top plates
- Optional adapter for 135 mm ø top plates



Cool-It™ Bowl - the virtually unbreakable dewar

The safe and efficient way of cooling and stirring round bottom flasks to $-78\text{ }^{\circ}\text{C}$

Cool-It replaces fragile glass dewars, unstable plastic bowls and keeps your chemistry colder for longer. The compact and virtually unbreakable Cool-It insulated bowls are designed to fit onto a standard stirring hotplate to cool and stir round bottom flasks, beakers and test tubes etc.

Cool-It keeps it cooler for longer

- Cool-It will keep your sample below $-70\text{ }^{\circ}\text{C}$ for up to 5 times longer than a plastic bowl.
- Cool-It will keep your reactions below $-70\text{ }^{\circ}\text{C}$ for twice as long as a glass dewar.



Two part lid be removed with flask in situ



Small Cool-It bowl for flasks up to 400 ml



Large Cool-It bowl for flasks up to 2 litres

Cool-It accessories

- Clamps, stand, digital thermometer, scoop, protective gloves, apron and face shield

Lid improves cooling

- Keeps reaction cool for up to 20% longer
- Easily fitted once your flask is in place
 - Minimises ice formation on flask
 - Prevents spitting

Virtually unbreakable

- Manufactured from a robust, chemically-resistant HDPE
- High quality insulated foam core
- Unlike fragile glass dewars is virtually unbreakable

Protects your stirrer and minimises spills

- Cool-It minimises frost on the outer surfaces, protecting your stirrer from moisture ingress
 - Cool-It fits securely on the top plate minimising spills and the risk of the bowl being knocked off the top plate



Easy pour spout and handle

- Non-drip spout and handle makes the disposal of solvents safer and easier
- Avoid spills for a safer working environment

Cool-It keeps it cooler for longer

- Cool-It will keep your sample below $-70\text{ }^{\circ}\text{C}$ for up to 5 times longer than a plastic bowl
- Cool-It will keep your reactions below $-70\text{ }^{\circ}\text{C}$ for twice as long as a glass dewar

Large and small bowl options

- Small for flasks up to 400 ml
 - Large for flasks up to 2 litres



Fits on all popular brands of stirring hotplate

- Suitable for use with top plates of 135 mm and 145 mm diameter

Cool-It accepts all shapes and sizes of round bottom and Florentine flask up to 2 litres



Easy pour design with spout and handle

Cool-It vs. Glass Dewar

Acetone and dry ice, 250 ml flask, 100 ml acetone

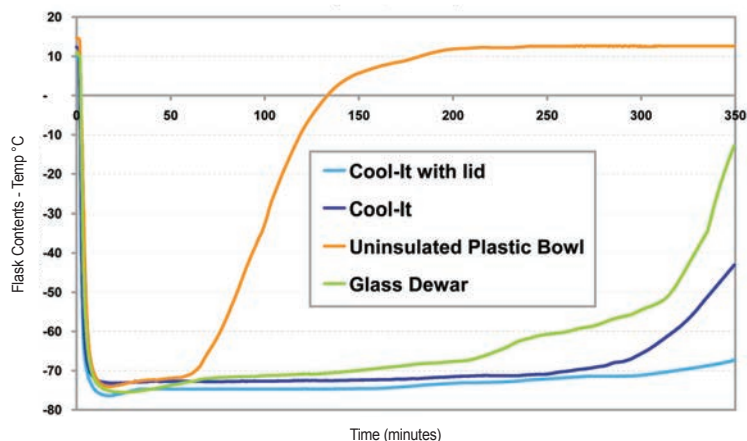

StarFish™ Multi-Experiment Work Station - *the space saver*

StarFish is a modular, general purpose heating and stirring work station

Whether you want to just heat and stir or perform more complex parallel experiments, StarFish really can make your life easier and improve productivity.

Features

- Fits all leading brands of stirring hotplate.
- Accepts vials, test tubes and round bottom flasks.
- Set up vessels individually or in parallel.



Applications

- Heating and stirring
- Synthesis
- Distillation
- Extraction
- Digestion
- Concentration



Space saving

Uses less space than multiple heating and stirring set-ups.

Increases productivity

Multiple positions allow you to heat, stir and reflux experiments in parallel.

Cost effective

Use your existing stirring hotplate and glassware. Eliminate the cost of multiple set-ups.

Safer, cleaner working

Eliminate oil baths, reduce spills, mess and accidents.

Flexible

Use as many positions as you want.

Easy to use

Easy to store and quick to assemble.

Compact

Store spare components in a drawer and not on the bench.

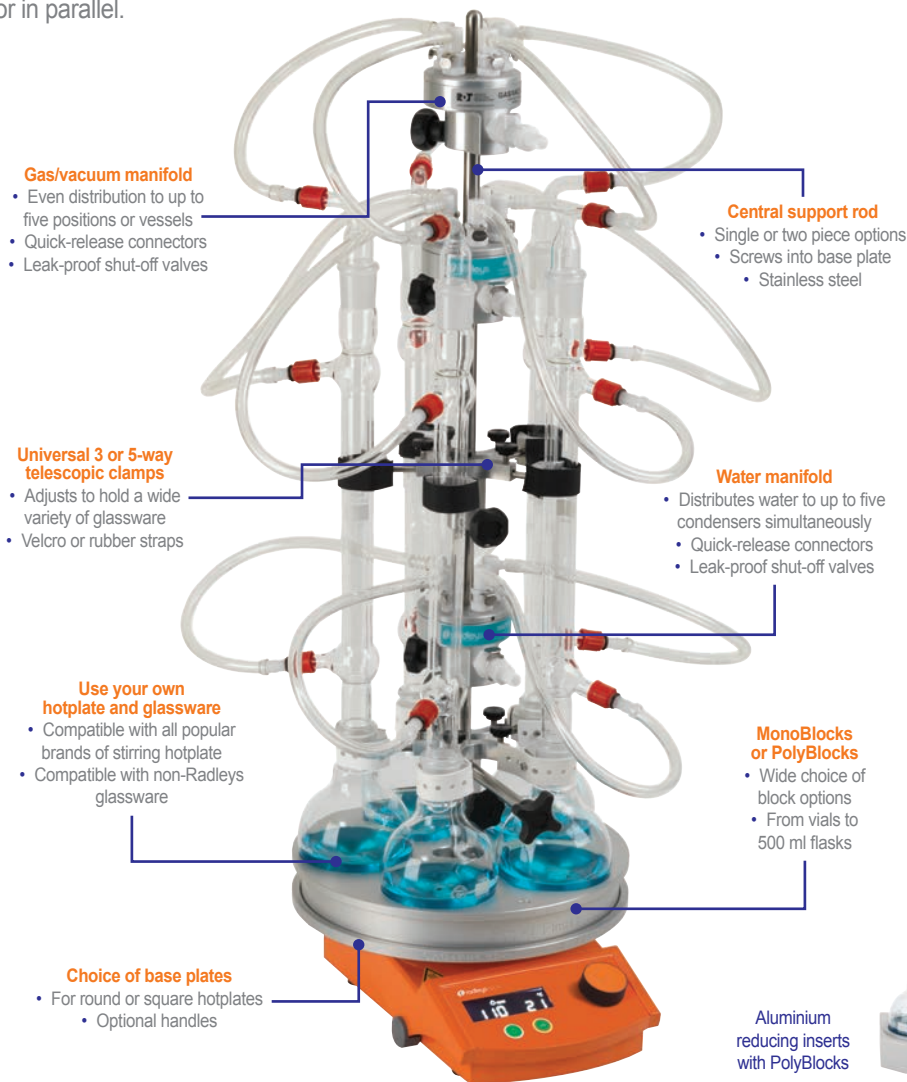

Gas/vacuum manifold

- Even distribution to up to five positions or vessels
- Quick-release connectors
- Leak-proof shut-off valves

Central support rod

- Single or two piece options
- Screws into base plate
 - Stainless steel

Universal 3 or 5-way telescopic clamps

- Adjusts to hold a wide variety of glassware
- Velcro or rubber straps

Water manifold

- Distributes water to up to five condensers simultaneously
- Quick-release connectors
- Leak-proof shut-off valves

Use your own hotplate and glassware

- Compatible with all popular brands of stirring hotplate
- Compatible with non-Radleys glassware

MonoBlocks or PolyBlocks

- Wide choice of block options
- From vials to 500 ml flasks

Choice of base plates

- For round or square hotplates
 - Optional handles

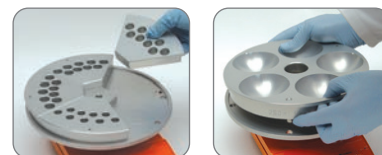

PolyBlock

MonoBlock

Aluminium reducing inserts with PolyBlocks



Mix 'n' match the components you need, when you need them

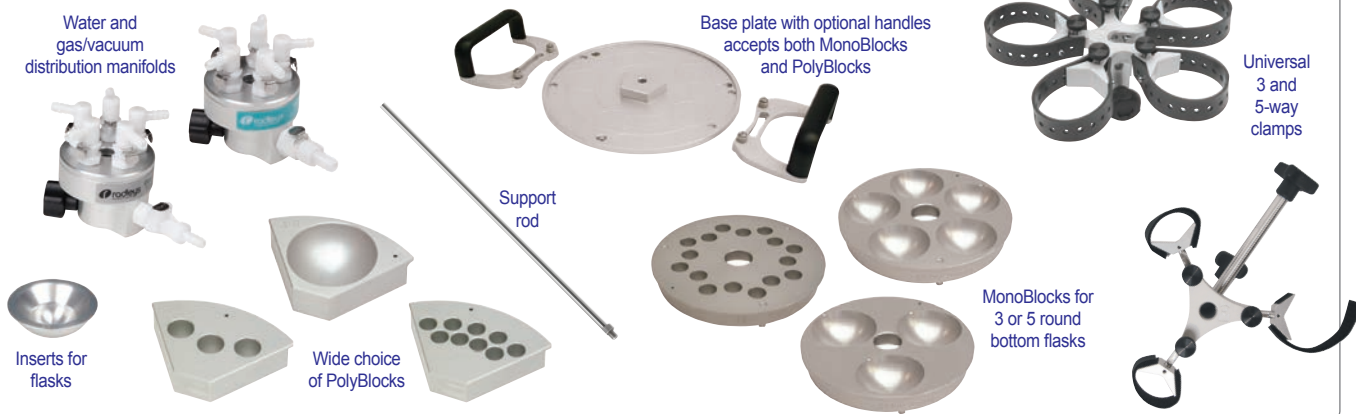

Water and gas/vacuum distribution manifolds

Base plate with optional handles accepts both MonoBlocks and PolyBlocks

Universal 3 and 5-way clamps

Support rod

MonoBlocks for 3 or 5 round bottom flasks

Inserts for flasks

Wide choice of PolyBlocks



Carousel Core+ and Heat-On 500 ml block



Carousel Core+ and Carousel 6 Plus Reaction Station



Carousel Core+ and Tornado Overhead Stirring System

Carousel Core+ Stirring Hotplate

800 Watt heating power with a chemically resistant top plate



Features

- Hotplate temperature range: 20 to 300 °C.
- Speed range 100 to 1400 rpm.
- Digital display of temperature and speed with both set and actual values.
- Temperature and rotation knobs can be locked to prevent changing of set values.

Faster heating

- 800 Watt heating power – heats rapidly.
- Reduces heat-up times by 35%.

Kera-Disk® top plate

- Rapid heat transfer for fast heating.
- Chemical and scratch resistant.
- 135 mm diameter.

Stirring control

- Powerful and even stirring.
- Smooth ramp to set speed which prevents decoupling of magnet.
- Pt1000 temperature sensor
- For precise control by solution or block temperature.
- Accuracy with sensor ± 1 K.

Safety features

- Carousel Core+ Stirring Hotplate provides built-in safety features as standard to protect both the user and the sample.

Sealed housing

- Hermetically sealed against solvent and vapour for long lifetime.



Pt1000 Stainless Steel Temperature Sensor

Stirring Hotplate Specifications

Model	Carousel Core+ Stirring Hotplate
Dimensions (W x H x D)	168 x 101 x 299 mm
Usable surface top plate	Ø 135 mm
Weight approx.	3 kg
Maximum permissible load	25 kg
Drive	EC motor, left-turning
Speed range	100 – 1,400 rpm
Adjustment accuracy	5 rpm
Heating power	800 W at 230 V (EU) 600 W at 115 V (US)
Heating temperature range	20 – 300 °C
Heating control	PID
Adjustment accuracy	± 1 K
Measurement accuracy (DIN IEC 751 Class a)	± 0.2 K, plus tolerance Pt1000
Measurement resolution	± 1 K
Display	LCD display
Protection class	(EN 60529) IP42
Acoustic pressure	< 50 dB(A)

Hei-Torque™ Overhead Stirrers - for powerful stirring

The powerful Hei-Torque range can accomplish the most demanding mixing tasks whilst providing the highest safety combined with a unique user interface



Features

- Powerful stirring from 10 to 2000 rpm.
- Available with basic (Expert) or advanced (Ultimate) features and a choice of up to 40, 100, 200 or 400 Ncm of torque.
- Intuitive touch panel for easy operation including safe start and stop via a slide touch panel to avoid accidental start-up.
- Sealed housing complies with IP 54 high protection from aggressive liquids and vapours.
- Guaranteed long life and maintenance-free, designed for 24-hour operation.
- Newest motor generation for maximum power at minimum noise level - below 50 dB.
- Reduce process times with VISCO JET® impellers for mixing gels and other challenging media with ease.
- Ultimate range features: set speed limit, adjustable acceleration, set a torque limit.
- Quick-chuck for immediate and convenient 'one-hand' impeller changes, without tools.



Accessories

- Range of paddle designs available in stainless steel, PTFE and POM plastic.
- Range of fixed and telescopic stands.

Overhead Stirrer Specifications

	Hei-Torque Core	Hei-Torque Expert 100	Hei-Torque Expert 200	Hei-Torque Expert 400	Hei-Torque Ultimate 100	Hei-Torque Ultimate 200	Hei-Torque Ultimate 400
Power rating, motor input/output (W)	105/75	90/50	120/80	150/90	90/50	120/80	150/90
Number of gears	1	1	1	2	1	1	2
Speed range (rpm)	20 to 2000	10 to 2000	10 to 2000	10 to 400 and 20 to 2000	10 to 2000	10 to 2000	10 to 400 and 20 to 2000
Speed indicator	digital monochrom 2"	digital monochrom 2.4"	digital monochrom 2.4"	digital monochrom 2.4"	digital colour 3.2"	digital colour 3.2"	digital colour 3.2"
Speed control	electronic	electronic	electronic	electronic	electronic	electronic	electronic
Set speed limit					yes	yes	yes
Adjustable acceleration					yes	yes	yes
Torque, max (Ncm)	40	100	200	400	100	200	400
Torque indicator	symbol	symbol	symbol	symbol	precise value	precise value	precise value
Set torque limit					yes	yes	yes
Overheat protection	automatic cut-out	automatic cut-out	automatic cut-out	automatic cut-out	automatic cut-out	automatic cut-out	automatic cut-out
Viscosity, max. (mPa·s)	10,000	60,000	100,000	250,000	60,000	100,000	250,000
Stirring cap. (H ₂ O) max. (L)	25	50	50	100	50	50	100
Analogue/digital interface					USB & RS232	USB & RS232	USB & RS232
Counter /Timer					yes	yes	yes
Shaft diameter, max. (mm)	10.5	10.5	10.5	10.5	10.5	10.5	10.5
Dimensions (W x H x D) (mm)	70 x 281.5 x 195	86 x 350 x 247	86 x 350 x 247	93 x 350 x 247	86 x 350 x 247	86 x 350 x 247	93 x 350 x 247
Weight (kg)	2.3	4.4	5.1	5.3	4.4	5.1	5.3



Simple and convenient, the Carousel Work-Up Station will reduce post-synthesis bottlenecks.



Work-Up Station for parallel or sequential work-up of 12 samples, using filtration, phase separation, liquid/liquid extraction or SPE.

Carousel 12 Plus Reaction Station™

The patented Carousel 12 Plus simultaneously heats/cools, stirs and refluxes multiple samples under an inert atmosphere

An effective personal synthesis station for parallel solution phase chemistry and solid supported reagent based synthesis.

Features

- Accepts up to 12 glass tubes with a reaction volume of 1 ml to 20 ml.
- Powerful, even stirring - fits onto a Carousel Stirring Hotplate.
- Rapid heating to 220 °C and cooling to -78 °C.
- Quick to set up and easy to use.
- Easy viewing of tube contents during experiments.
- Removable water-cooled reflux head.
- Perform reactions under an inert atmosphere.
- Fluoropolymer coating for chemical resistance and easy cleaning.
- PTFE caps feature a quick-thread for fast attachment to glass tubes.
- Removable reflux head allows reaction tubes to be transferred between heated base, cooled base or stand.



The world's most popular parallel synthesiser

Heated directly by the stirring hotplate with optional digital control and PT1000 temperature sensor.

Quick-release inlet/outlet for vacuum and gas, combined with a radial gas distribution system and gas-tight caps, allow reactions under an inert atmosphere.

Water-cooled aluminium reflux head provides efficient refluxing within individual reaction tubes

Chemical-resistant Easy-On PTFE caps feature a quick-thread for fast attachment to the glass tubes and push-on connections to the s/steel gas outlets.



Accepts up to 12 tubes with reaction volume of 5 to 20 ml (1 ml with reduced volume tubes).

Quick-release water couplings with cut-off valves for ease of connection to cooling water supply.



Easy to operate and set up with minimal training. No electrical or moving parts ensure maintenance-free operation.

Fluoropolymer coating for chemical resistance and easy cleaning.

Unique removable fluoropolymer insulation plate helps insulate the heated base for faster heating and energy savings of up to 36%.

Base design improves heat transfer and provides energy savings. Maximum operating temperature 180 °C (220 °C for short periods).

Visibility slots allow easier viewing of tube contents. Easy to rotate round design gives access to all tubes with no need to lean into the fume cupboard.

Utilises the single rotating magnetic field of the hotplate stirrer to stir all the positions evenly and powerfully.

Rare earth cross shaped stirring bars for vigorous stirring and a deeper vortex, without jamming.



Carousel Stirring Hotplate offers higher temperature, powerful stirring and digital control.

Control and log your chemistry with AVA Software



Cooled Carousel 12 Plus Reaction Station™

Cost effective, low temperature parallel synthesis down to $-78\text{ }^{\circ}\text{C}$

The innovative Cooled Carousel 12 Plus reservoir is designed to accept the removable reflux/inerting head from the Carousel 12 Plus, allowing reaction tubes to be easily and rapidly transferred between heating and cooling bases.

Features

- Simultaneously performs 12 cooled and stirred reactions to $-78\text{ }^{\circ}\text{C}$.
- Powerful, even stirring - reservoir fits on to a Carousel Stirling Hotplate.
- Robust HDPE cooling reservoir is compatible with a wide range of cooling mixtures, including dry-ice/acetone for manually controlled cooling from ambient down to $-78\text{ }^{\circ}\text{C}$.
- Features a non-drip spout and handle for disposal of waste solvents.
- Insulated foam core maintains low temperatures for long periods whilst protecting the stirrer from freezing. Also reduces condensation and ice formation on outer surfaces.
- HDPE lid keeps your reaction cooler for longer, minimises ice formation on your tubes (maintaining visibility of the contents) and prevents spitting from the cooling mixture.
- The robust HDPE reservoir is virtually unbreakable.



Upgrade your Carousel to perform cooled chemistry



Transfer the reflux/inerting head to the cooled reservoir



Carousel 12 Plus Stand

The Carousel stand is designed to support the reflux/inerting head either with or without reaction tubes.

The heavy duty metal stand is fluoropolymer coated for improved chemical resistance and ease of cleaning. The integral drip tray catches any dripping condensation from tubes and gives excellent stability.



The Tornado integrates with the Carousel 6 Plus to provide powerful, controlled mechanical stirring of up to six round bottom flasks.

Offers unrivalled stirring for both viscous samples and for the dispersion of delicate solids in solution.

See page 16



Carousel 6 Plus Reaction Station™

The patented Carousel 6 Plus simultaneously heats, stirs and refluxes multiple samples under an inert atmosphere

Accepts round bottom flasks: 5 ml, 10 ml, 25 ml, 50 ml, 100 ml, 170 ml and 250 ml sizes.

Features

- Powerful, even stirring - fits onto a Carousel Stirring Hotplate.
- Rapid heating to 180 °C.
- Quick to set up and easy to use.
- Water-cooled reflux head.
- Perform reactions under an inert atmosphere.
- Easy viewing of flask contents during experiments.
- 100 ml and 250 ml azeotropic (Dean Stark) flask option.
- PTFE caps feature a quick-thread for fast attachment to flasks.

180°C



A wide range of accessories including liquid additions funnels, powder funnels and rotary evaporator adapters



Control and log your chemistry with AVA Software



Aluminium inserts for 5 ml, 10 ml, 25 ml, 50 ml, 100 ml and 170 ml flasks

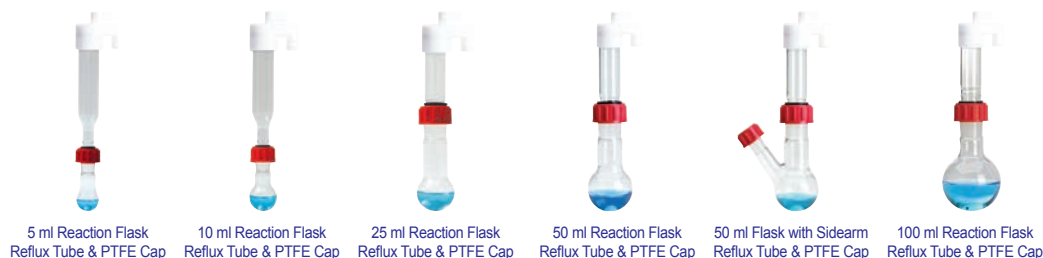

5 ml Reaction Flask
Reflux Tube & PTFE Cap

10 ml Reaction Flask
Reflux Tube & PTFE Cap

25 ml Reaction Flask
Reflux Tube & PTFE Cap

50 ml Reaction Flask
Reflux Tube & PTFE Cap

50 ml Flask with Sidearm
Reflux Tube & PTFE Cap

100 ml Reaction Flask
Reflux Tube & PTFE Cap

Cooled Carousel 6 Plus Reaction Station™

Cost effective low temperature parallel synthesis down to $-78\text{ }^{\circ}\text{C}$

The Cooled Carousel 6 Plus allows chemists to perform sub-ambient reactions in a range of flasks from 5 ml to 250 ml with the option of an inert, moisture-free atmosphere.

Features

- Simultaneously perform up to six cooled and stirred reactions to $-78\text{ }^{\circ}\text{C}$.
- Powerful, even stirring - reservoir fits on to a Carousel Stirling Hotplate.
- Robust HDPE cooling reservoir is compatible with a wide range of cooling mixtures, including dry-ice/acetone for manually controlled cooling from ambient down to $-78\text{ }^{\circ}\text{C}$.
- Insulated foam core maintains low temperatures for long periods, whilst protecting the stirrer from freezing. Also reduces condensation and ice formation on outer surfaces.
- HDPE lid keeps reactions cooler for longer, minimises ice formation on flasks (maintaining visibility of the contents) and prevents spitting from the cooling mixture.
- Round design makes all reaction flasks visible and allows easy addition of reagents and solvents, with no need to lean into the fume hood.

$-78\text{ }^{\circ}\text{C}$



Visit www.radleys.com to download a PDF on the Cooled Carousel 6 Plus



HDPE lid reduces frost formation and reduces the risk of solvents spitting.

Insulated foam core maintains low temperatures for long periods whilst protecting the stirrer from freezing and also reduces condensation and ice formation on outer surfaces

Utilises the single rotating magnetic field of the hotplate stirrer to stir all the positions evenly and powerfully



Fits on a standard Carousel Stirling Hotplate

Compact size has a small bench-top footprint and is easy to store

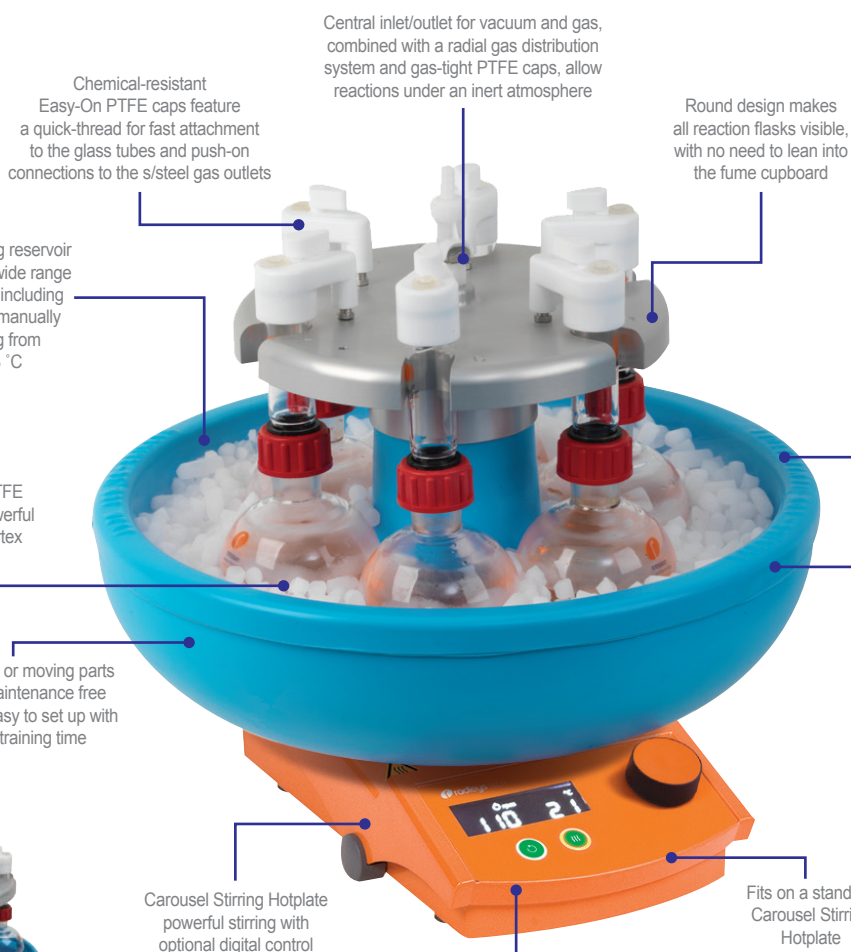

Chemical-resistant Easy-On PTFE caps feature a quick-thread for fast attachment to the glass tubes and push-on connections to the stainless steel gas outlets

Central inlet/outlet for vacuum and gas, combined with a radial gas distribution system and gas-tight PTFE caps, allow reactions under an inert atmosphere

Round design makes all reaction flasks visible, with no need to lean into the fume cupboard

Robust HDPE cooling reservoir is compatible with a wide range of freezing mixtures including dry-ice/acetone for manually controlled cooling from ambient to $-78\text{ }^{\circ}\text{C}$



Rare earth elliptical PTFE stirring bar provides powerful stirring and a deep vortex

No electrical or moving parts ensures maintenance free operation. Easy to set up with minimal training time

Carousel Stirling Hotplate powerful stirring with optional digital control



100 ml Flask with Sidearm Reflux Tube and PTFE Cap



170 ml Reaction Flask Reflux Tube and PTFE Cap



250 ml Reaction Flask Reflux Tube and PTFE Cap



250 ml Wide Neck Vessel



250 ml Flask with 2 Sidearms with Dropping Funnel



250 ml Reaction Flask with Dropping Funnel



250 ml Azeotropic Reaction Flask with Dropping Funnel



Tornado with 250 ml wide neck flasks

Tornado™ Overhead Stirring System

Use a single overhead stirrer to stir up to six round bottom flasks from 50 ml to 250 ml simultaneously. Increase your stirring productivity by up to 600%

The Tornado allows powerful, controlled mechanical stirring of round bottom flasks with the Carousel 6 Plus Reaction Station, offering unrivalled stirring for both viscous samples and for the dispersion of delicate solids in solution.



Features

- Integrates with Carousel 6 Plus to provide heated and stirred reactions.
- Rapid heating to 180 °C with water-cooled reflux head.
- Perform reactions under an inert atmosphere.
- Accepts 50 ml, 100 ml and 250 ml round bottom flasks.
- Uses a single overhead stirrer - save space and money compared to multiple set-ups.
- Compatible with all leading brands of overhead stirrer.
- 2-speed drive allows overhead stirrers with less torque to be used for higher viscosities.
- Max. viscosity 10000 mPas at 500 rpm
- Stir to 1000 rpm in low viscosity.

PTFE stirring shafts

Choice of centrifugal, anchor and propeller PTFE stirrers, specifically sized for each vessel.

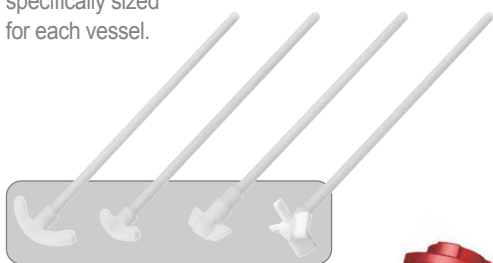

Choice of flask sizes and styles with wide neck option

Wide neck flasks allow easier removal of viscous and solid samples and the use of larger stirrer blades. Baffles also improve stirring by disturbing the creation of a vortex.

Azeotropic vessels

250 ml azeotropic (Dean Stark) flask option.

250 ml azeotropic vessel with dropping funnel and centrifugal PTFE stirrer



Compatible with all leading brands of overhead stirrer

Heated directly by the stirring hotplate with optional digital control and Pt1000 temperature sensor

Tool-free pinch-grip mechanism and sealed stirrer shaft insertion system allows easy stirrer shaft insertion and operation under an inert atmosphere

Integral polycarbonate safety guard

Provides up to six heated (max +180 °C) and stirred reaction positions

Universal support stand gives added stability



Uses a single overhead stirrer to agitate up to six 250 ml flasks

Easy to operate and set up with minimal training time

2-speed drive (1:1 and 2:1) allows lower rated stirrers to be used for higher viscosity liquids



Individual vessels can be removed easily

Accepts 50 ml, 100 ml and 250 ml round bottom flasks (sidearms and baffled flasks available)

Fits on a standard Carousel Stirring Hotplate

Integrates with existing Carousel 6 Plus without increasing footprint

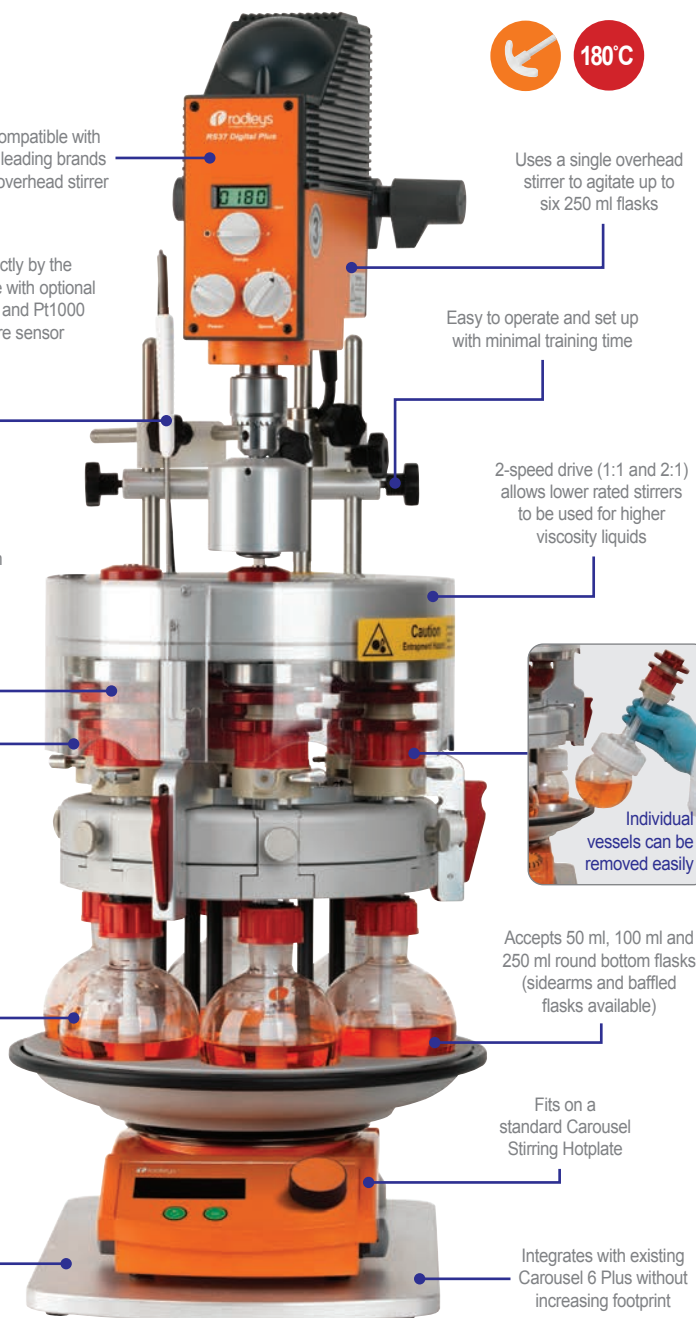

Breeze™ Heating/Cooling Work Station

When combined with a circulator, the compact Breeze provides rapid heating/cooling and is ideal for applications requiring precise control by solution temperature

Designed as an add-on module for the Carousel 6 Plus and Tornado, Breeze creates a parallel process reactor for controlled heating and cooling. Breeze is ideal for applications that require fast and precise solution temperature control, such as crystallisation studies.



Features

- Thermofluid -85 °C to +235 °C providing a solution temperature of -30 °C to +165 °C.
- 135 mm ø top plate integrates with the Carousel 6 Plus, Tornado, and Heat-On.
- Breeze's small internal volume ensures a quick response to changes in thermofluid temperature.

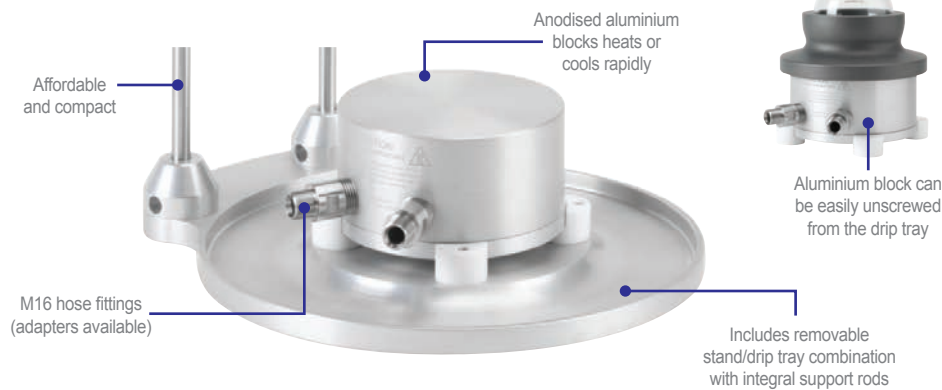

Breeze with 250 ml Heat-On, stand and overhead stirrer

Storm™ Heating/Cooling Work Station

Combined with a suitable circulator, Storm can provide controlled steady state heating and cooling



Designed as an add-on module for the Carousel 6 Plus and Tornado combination, Storm creates a powerful parallel process reactor for controlled heating and cooling, making it the ideal process optimisation and development tool.

Features

- Thermofluid -85 °C to +235 °C providing a solution temperature -65 °C to +200 °C.
- 135 mm ø top plate integrates with the Carousel 6 Plus, Tornado and Heat-On.
- Unique internal design maximises heat transfer whilst the insulated outer case reduces heat loss and prevents contact with hot/cold thermofluid.



Storm with Carousel 6 Plus, Tornado, overhead stirrer and PTFE insulating plate



Carousel 6 Plus locates on to the Storm without tools

GreenHouse Work-Up provides rapid sequential and parallel purification in a 24 well MTP footprint using standard filtration, phase separation and SPE columns.

Designed to make your parallel chemistry work-up and purification quick and easy. See page 20.



GreenHouse Plus Parallel Synthesiser™

The GreenHouse Plus provides 24 heated and stirred glass reactions with volumes from 0.5 ml to 7 ml. The combined reflux and additions head allows for convenient additions or withdrawals whilst maintaining an inert atmosphere



GreenHouse Plus brings all the benefits in productivity of parallel synthesis at a fraction of the cost of automated systems. Holding 24 glass reaction tubes in a removable reaction block with the same footprint as a standard microtiter plate (MTP), the GreenHouse Plus facilitates rapid transfer of samples by multi-channel pipettor or robotic systems.

Features

- Powerful stirring and rapid heating to 150 °C.
- Removable water-cooled reflux head.
- Perform reactions under an inert atmosphere.
- Easy viewing of tube contents during experiments.
- Nickel-plated aluminium offers excellent chemical resistance.

Designed for the synthesis of small compound libraries and drug discovery

Can be converted into GreenHouse Blowdown Evaporator

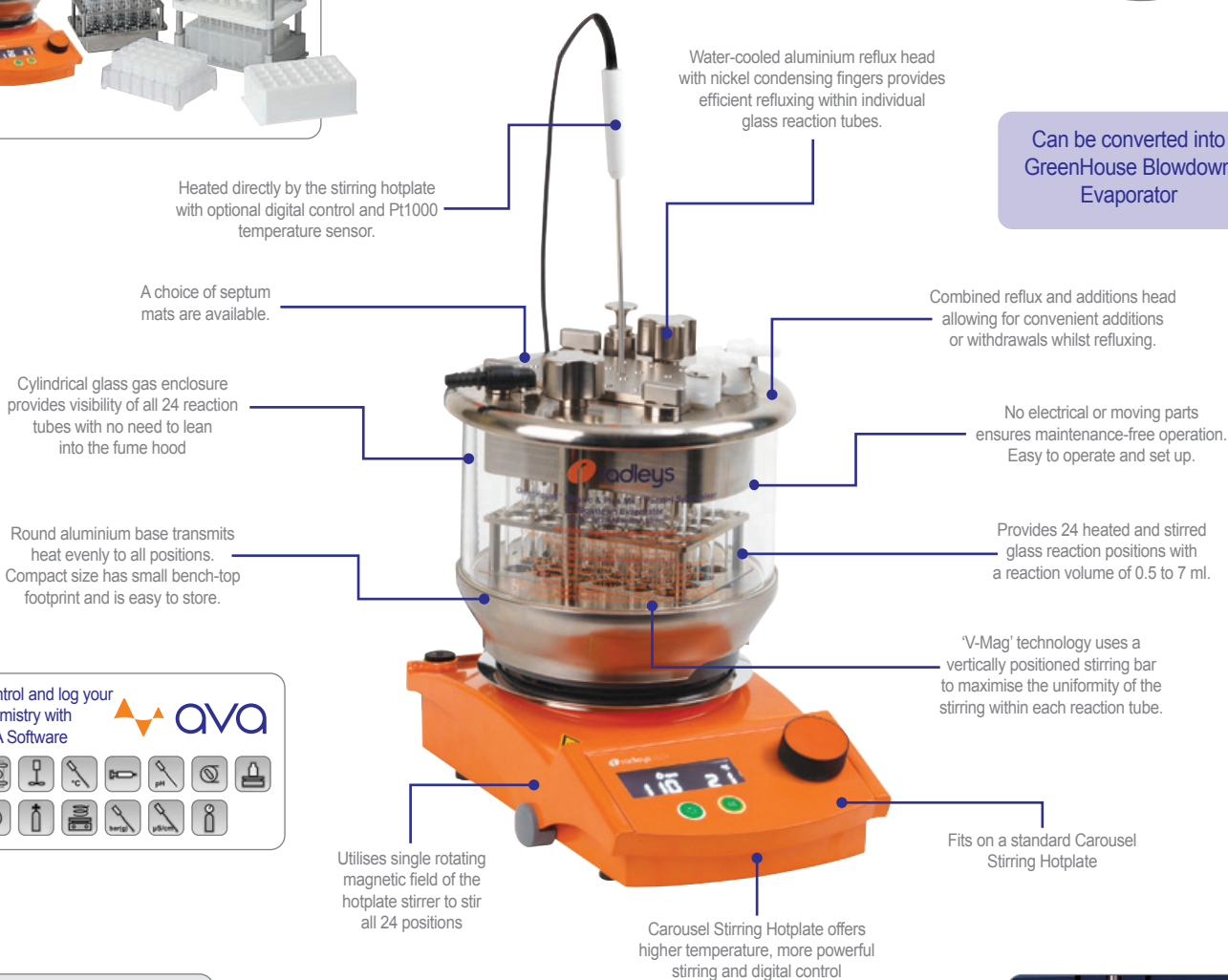

Control and log your chemistry with AVA Software



Combined reflux and additions head with nickel condensing fingers



GreenHouse Plus allows additions and withdrawals through sealing mats



Reaction block fits directly into Genevac vacuum centrifuges



GreenHouse Blowdown Evaporator™

Parallel evaporation of samples in 8 or 24 vials, tubes and microtiter plates

Features

- Precise control of inert gas flow combined with digital control of heating carefully evaporates your samples.
- Interchangeable plates with either 8 or 24 hollow blowdown pins deliver an equal flow of gas to each tube, vial or well.
- The absence of a vacuum avoids bumping, protecting the sample during evaporation.
- Nickel-plated aluminium offers excellent chemical resistance.
- Easy viewing of samples during evaporation.
- Optional flowmeter precisely controls flow of inert drying gas.

Compatible with:

- 7 ml GreenHouse tubes
- 8 or 24 position vial racks
- 13 mm, 13.8 mm, 15 mm, 24.3 mm & 27.8 mm \varnothing vials
- 8 or 24 well microtiter plates



Precise heat control and the absence of a vacuum protects your sample and avoids bumping.

Safety relief valve on inlet prevents over-pressure during operation.

Evaporate 8 vials, each containing 5 ml of methanol, in only 22 minutes

Removable head features quick-release handles for easy exchange of Blowdown pin plates.

Select the appropriate Blowdown pin plate. Interchangeable plates with either 8 or 24 hollow pins deliver an equal flow of gas to each tube, vial or well.



Digitally controlled heating from the hotplate gently adds energy to the sample to speed the evaporation process.

Blowdown system with 24 pin plate, standard GreenHouse base, reaction block and 7 ml tubes

Control and log your chemistry with AVA Software

Enclosed design contains evaporating solvent, allowing subsequent trapping and collection of solvent via a high performance glass condenser

Can be converted into GreenHouse Plus Parallel Synthesiser

Typical Evaporation Times

Solvent	Samples	Volume	Vessel	Evap. Time
Methanol	24	2 ml	3.5 ml vial	20 mins
Methanol	8	5 ml	20 ml vial	22 mins
Acetonitrile	24	2 ml	3.5 ml vial	20 mins
Acetonitrile	24	2 ml	7 ml tube	35 mins
Water	8	5 ml	20 ml vial	157 mins
DMF	24	2 ml	3.5 ml vial	138 mins
DMF	24	2 ml	7 ml vial	145 mins

40°C Base Temperature. Flow rate 10 l/min (8 well), 20 l/min (24 well)

Insert the adapter into the GreenHouse base to accept vial racks or titre plates...

...or use the dedicated, low profile, Blowdown base.



Insert the adapter into the GreenHouse base



GreenHouse base and 24 position vial rack



GreenHouse base and 8 position vial rack



GreenHouse base and 24 position MTP



Blowdown base and 24 position vial rack



Blowdown base and 8 position vial rack



Blowdown base and 24 position MTP

24 Position Parallel Work-Up

Designed to make your parallel chemistry work-up and purification quick and easy.



GreenHouse Work-Up Station™

Rapid, sequential, parallel purification in a 24 well, microtiter plate footprint using standard 3 ml or 6 ml filtration, phase separation and SPE columns

Features

- Innovative, stacked column design allows sequential purification e.g. phase separation and SPE or filtration and SPE.
- Removable, upper support plate allows unit to be used for single or sequential purification.
- Clear gas cover allows pressure to be applied to increase flow rate of difficult samples. Accommodates all standard 3 ml and 6 ml tabbed or tabless SPE or filtration columns.
- Accepts all standard 24 well microtiter plates, as well as GreenHouse reaction blocks for fraction collection.
- Full range of filtration, phase separation and SPE columns including silica, SCX, aminopropyl and SAX acetate.

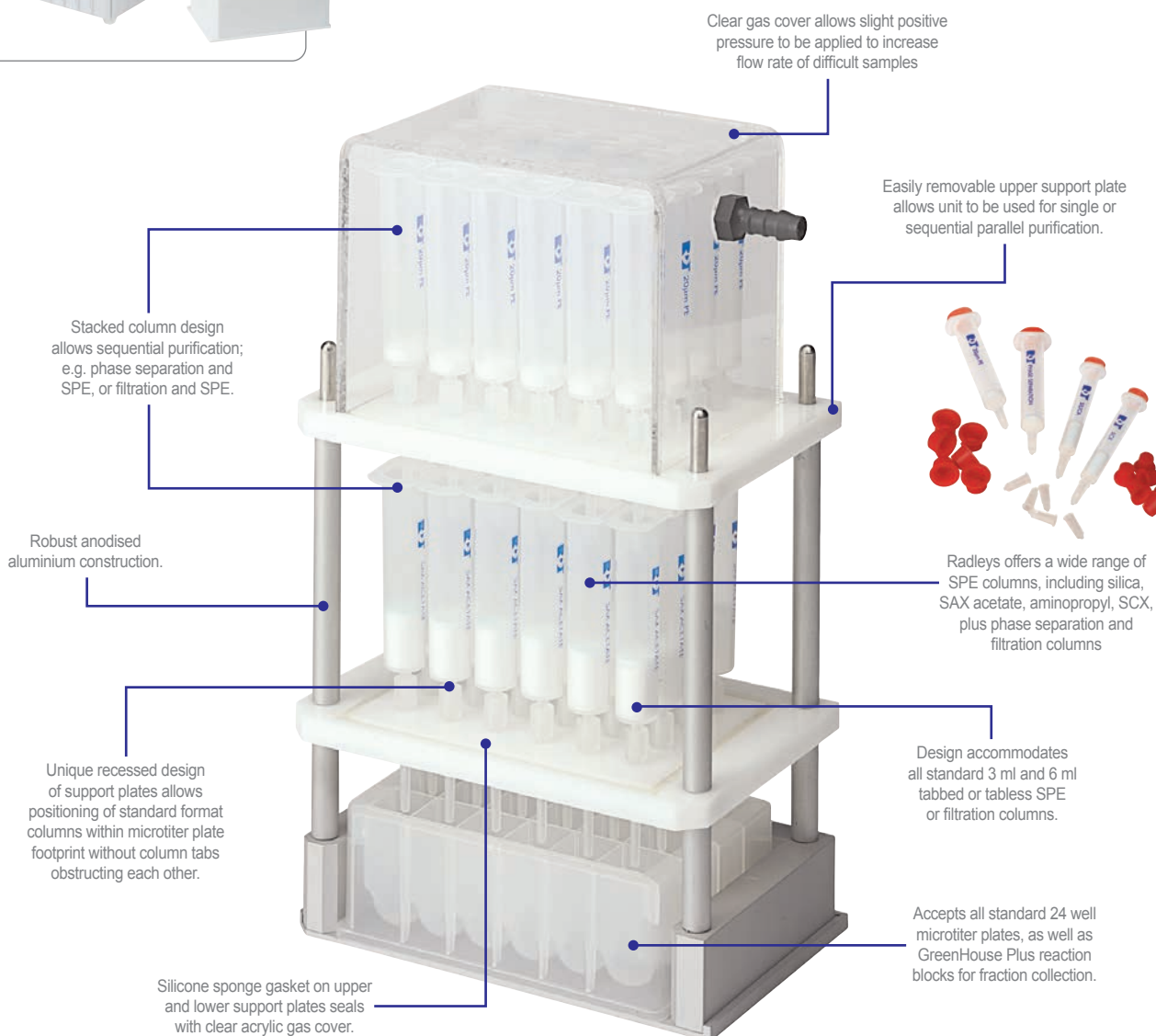

Carousel Work-Up Station™

Easy-to-use, the Carousel Work-Up Station reduces post-synthesis bottlenecks

Features

- The Carousel Work-Up Station facilitates parallel or sequential work-up of up to 12 samples, using filtration, phase separation, liquid/liquid extraction or SPE techniques.
- The Carousel Work-Up Station accepts 12 x 70 ml columns loaded into one of two identical stackable racks.
- The lower rack supports 12 corresponding Carousel reaction tubes or standard 1 inch boiling tubes for subsequent sample collection.
- SpeediFlow Booster increases flow rates to speed up your work-ups.

Carousel 12 Plus 12 Position Parallel Work-Up

Designed to make your parallel chemistry work-up and purification quick and easy.



Use under gravity or with the SpeediFlow Booster, which allows pressurisation of individual columns to increase flow rates and speed up your work-ups.

Aluminium racks are exceptionally stable, with good access and visibility of all columns and tubes.

Each position is numbered 1 to 12 for ease of identification. The racks will only locate in one orientation.

Accepts 70 ml columns including 20 µm filtration, phase separation, liquid/liquid extraction, silica, SCX, aminopropyl and SAX acetate.

Unique design uses no taps, valves or drip needles, making assembly and operation fast and simple. Minimises cleaning time and consumable costs

Vacuum-free operation makes removal of collection tubes easy, prevents drying of columns and reduces the risk of bumping

Accepts 12 x Carousel reaction tubes or standard 1 inch boiling tubes

An optional 3rd rack can be stacked above the 2nd rack for sequential work-up.



To locate a second rack on top of the first, pull out the spring loaded knob and rotate 90°.

Ergonomically designed, lightweight aluminium racks are easy to load with collection tubes or work-up columns.

Identical racks lock together for ease of operation or transportation from location to location.

Insert SpeediFlow nozzle into the column.

Squeeze trigger and press the thumb button until it locks.

Release the trigger for a gas tight seal with column.

A constant pressure is maintained in the column.

Gasflow will now speed up the flow of your sample.

To remove, squeeze the trigger and the thumb button will release.





Webinars - From our Experts

Scan the QR code to visit our website and watch our extensive range of Webinars on demand.

www.radleys.com/webinars/

**From Flask to File:
Data Acquisition
in Synthesis**



25'
WEBINAR

radleys
PRESENTS

**Scaling up crystallisation:
Insights from CatSci
and BlazeMetrics**

With speakers from

CatSci
EXCELLENCE IN MEDICINES DEVELOPMENT

BlazeMetrics

60'
WEBINAR

**Tips for performing low
temperature reactions**



20'
WEBINAR

**Efficient Process
Development with DoE**



15'
WEBINAR

**Optimising Mixing:
Techniques for
Better Reactions**



15'
WEBINAR

**Automated Dosing in
Jacketed Lab Reactors**



20'
WEBINAR

**Making the most
of your hotplate**



20'
WEBINAR

**Radleys Customisable
Jacketed Lab Reactors**



25'
WEBINAR



Videos - YouTube

Scan the QR code to access our library of informative videos on our YouTube channel.

www.youtube.com/@RadleysChemistry

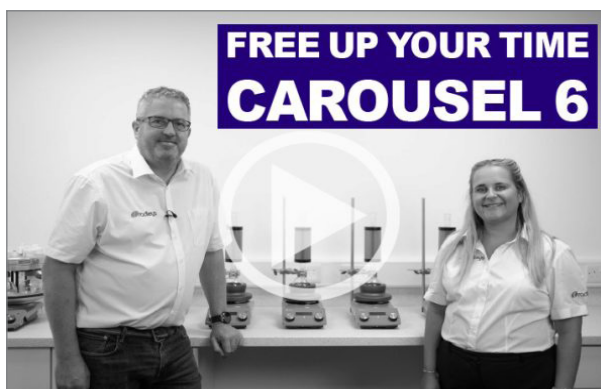
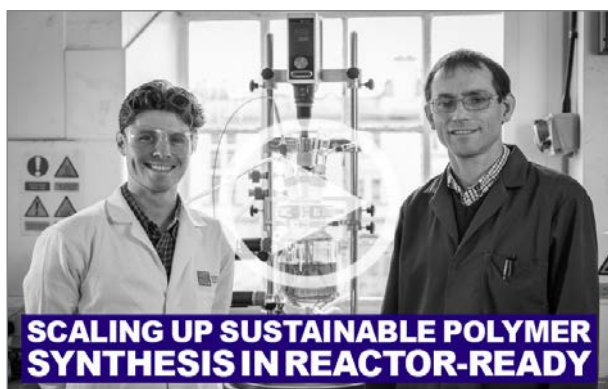
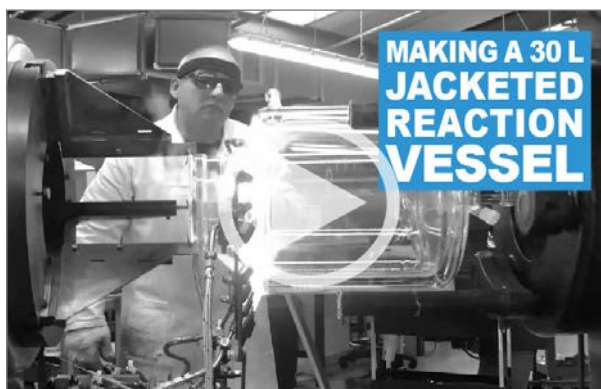

Accelerating chemistry



Our amazing team of international distributors at our distributors awards event

Radleys provide innovative productivity tools helping chemists discover amazing things.
Chemistry equipment for safer, cleaner, greener and more productive chemical research.

Visit www.radleys.com to see our full range of chemistry productivity tools.



© Radleys (R.B.Radley & Co Ltd), March 2026

Interchim S.A.S - 211 bis avenue J.F. Kennedy - 03100 Montluçon - France - Tel. : +33 4 70 03 88 55 - email : info@advion-interchim.com
www.advion-interchim.com - www.interchim.com - www.flash-chromatography.com - 1.548.000 € - RCS Montluçon 917 050 171 - APE 4669 B
Advion Interchim Scientific is the market-facing name of a partnership between Advion, Inc. and Interchim SAS, separate companies that have agreed to market and distribute their products together